



Checklist for Bidders

Enquiry #: 14231

Opening Date: _____

Time: _____

M/s, _____

Please ensure before submitting the bid, that following information/ Documents have been submitted / providing along the bid. Kindly Check () appropriate box.

Sr. No.	Checklist Item	Action Required	(Yes/ No)
1	Tender Document Availability on SSGC website & EPADS	Ensure the bidder participates via EPADS.	
		Download the tender document from EPADS.	
		Fill the BOQ/ Bid Form/ Schedule of Requirement correctly.	
		Submit the bid on EPADS before the deadline; otherwise, bid will be rejected.	
2	Physical Bid Bond Submission	Submit the physical bid bond to the Tender Room (SSGC HO) before the bid submission. And upload Scanned copy of Bid bond on EPADS.	
		If Bid Bond in original not submitted, the bid will be rejected.	
3	Bid Submission Deadline	Confirm all documents (electronic and bid bond in original) are submitted before the specified bid submission deadline.	
4	Signature and Stamp	Ensure all documents are signed and stamped as required and uploaded on EPADS or else bid will be rejected	
5	Additional Documents (if any)	Verify if any other documents specified in Tender document are included in the bid on EPADS.	
6	Tender Fees	Rs. 0 (Free)	
7	Technical literature	Original Technical literature is enclosed, if any duly signed & stamped	
8	Any change in your current address, Phone Fax no & Email etc. intimated	Bidders are required to intimate Procurement dept. for any change in Current address, email, contact information etc. in tender documents	
9	Bid validity	Bid Validity as specified is mentioned	
10	Delivery / Completion period	Delivery / Completion period has been specified as per tender terms	
11	Corrections/Cutting/Overwriting	All corrections/cutting/overwriting are signed & stamped	
12	Sample	Sample (if necessary) is enclosed as per form attached in Tender Document	
13	Form-X	Form- X Duly Signed & Stamped	

Note:

Non-Availability of the above information/documents, or incomplete/incorrect statement on this checklist may result in rejection of the bid at / after the bid opening.

As per SRO296(1)/2023 dated 08th March 2023 "E-Pak Procurement Regulations, 2023" all bidders are advised to register in e-Pak Acquisition and Disposal System (EPADS).



Bidders Authorized Representative



M/s. _____

CIVIL WORKS LAYING OF CC PAVER BLOCKS

Under Single Stage One Envelope Bidding Procedure

(Under the PPRA Rules 2004)

Supplier must be active in FBR Active Taxpayer List (ATL)

Tender Enquiry No. SSGC / SC / PT / 14231

Invitation to Bid

SECTION - I

Sui Southern Gas Company Limited (SSGC) is Pakistan's leading integrated gas Company. The company is engaged in the business of transmission and distribution of natural gas in franchise area of Sindh & Balochistan.

Sui Southern Gas Company Limited (SSGCL) intent to carry out the work related to *Civil Works Laying Of CC Paver Blocks (12000 Sft) at Industrial Area, Karachi Terminal Karachi (as per BOQ) (Having Valid PEC Certificate Category C-6 or above having Specialization of CE-10)(Under Single Stage One Envelope Bidding Procedure) (On Complete Package Basis)*

The priced bids shall be submitted along with FIXED Bid Bond amounting Rs. 60,000 (Sixty Thousand only) in the form of Pay order / Demand Draft in favor of Sui Southern Gas Company Limited

The tender documents comprise the following:

- | | | |
|------------------|-------------|---|
| Section - | I | Invitation to Bid |
| Section - | II | Instruction to Bidder (A&B) |
| Section - | III | Scope of Work /Special Condition of Contract |
| Section - | IV | Special Conditions of Tender Document |
| Section - | V | General Terms & Conditions |
| Section - | VI | Tender Form |
| Section - | VII | Bill of Quantities (BOQ)/Bid Form |
| Section - | VIII | Bid Bond Format/Performance Bond /Format of Declaration/Contract Form/Form X/Annexure I/ Form of Bid Securing Declaration |
| Section - | IX-X | Blacklisting Mechanism/IMS Manual/SSTW-05 |





SSGC

Bids will be submitted online on EPADS Portal on or before **13-04-2026 at 1000** hours. The bids will be publicly opened at **1030** hours on same day online on EPADS in the presence of bidders and / or their authorized agents who may wish to attend.

Bids not conforming to the conditions stipulated in the tender documents may be rejected.

The Company reserves the right to add, delete or amend any part of the tender documents during the bidding period and bidders shall be informed of the same.

The Company reserves the right to reject any or all offers without assigning any reason.

The Company will appreciate confirmation by fax, addressed to General Manager (Procurement), Fax No. 99231583 of your intention to submit the bid.

The advertisement is also published in PPRA (www.ppra.org.net) & SSGC (www.ssgc.com.pk) websites respectively.



For **General Manager (Procurement)**





SECTION - I

INVITATION TO BID

SECTION - II

Instructions to Bidders

1. All rates quoted in the prescribed SOR / BOQ shall be firm, irrevocable and not subject to change or escalation on any account what so ever. No modification, alteration or deletion in the bid will be accepted after the bid opening time.
2. Sealed Bids shall be received at Company's Head Office, ST-4/B, Block - 14, Sir Shah Suleman Road, Gulshan-e-Iqbal, Karachi, up to specified time & date and will be opened publicly at specified time & date, in the presence of Bidders or their authorized representative who choose to attend. In case the bid opening date falls on a holiday or due to some unavoidable circumstances, it is not possible to open on scheduled date, it will be opened on next working day at the same time.
3. All original bid documents accompanied with the bid bond shall be submitted by the Bidder in the envelope provided with tender documents. The sealed Bids must be submitted at the address stated above in person or by courier or by any other means but it shall be the Bidder's responsibility to ensure that Bids so submitted are delivered to the above address before the specified Bid opening date and time. The Company shall not be held responsible in any way for late receipt of Bids or their confidentiality. Bids received after the Bid closing time shall not be considered, and will be returned to the Bidder unopened.
4. In Case of single stage two envelop bidding system (if mentioned in press advertisement & Tender document), sealed technical offer & sealed bid shall be submitted in separate envelopes (bid bond will be enclosed with "Financial" bid unless and until specified separately in tender terms). "Technical" and "Financial" is to be mentioned on the top of the envelop. Technical offers will be opened and evaluated first. Financial offer of only technically complaint bidders will be opened at a later intimated date in presence of bidder's representative. Financial offers of technically non-complaint bidders will be returned un-opened along with their bid bond.
5. The Bid should be signed by a person having the authority for this purpose. In case of a bid submitted by a corporate entity, the same shall bear its seal and be duly signed by its secretary.
6. Bids shall be submitted strictly in accordance with the requirements of the Tender Documents and as per specifications.
7. Bid shall remain valid for acceptance for a period of (120) days from the date of public opening of the bids.
8. The Company shall not reimburse any expenses incurred in preparation of Bids.
9. The Bid and all subsequent correspondence shall be in the English language.
10. Payment for the Contracted Work / Services will be made in Pakistani Rupees only. The rates quoted by the Bidder shall therefore, be in Pakistani Rupees.
11. In case of any queries / clarification with regard to this Tender, the same may be forwarded to Procurement Department upto 5 days before the bid opening date, thereafter the request will not be considered.
12. The Company reserves the right to reject any or all Bids without assigning any reason and cancel the bidding process. Company also reserves the right to accept the whole or a part of Bid and does not bind itself to accept the lowest or any particular Bid.
13. In case of any conflict between the Special Terms & Conditions and elsewhere in the tender documents the Special Term & Conditions, will supersede & prevail.
14. Each and every page of the bid documents being submitted by the bidders shall be signed and stamped failing which the bid may be liable for rejection.
15. All documentary evidence required for evaluation of bid should be submitted along with the bid in absence of any documentary evidence no marks will be awarded in accordance to the evaluation criteria.
16. In order to maintain cordial business relation and as per ethical business approach, please provide the justification in case of your non participation on our Fax # 99231583 & Email. mmte@ssgc.com.pk.
17. Conditional Bid will not be accepted and liable to be rejected.
18. The quoted unit price and corresponding total amount shall be inclusive of all duties and Taxes and excluding provincial Sales Tax as per provincial laws.
19. Sealed bids shall be mailed/submitted/dropped in tender box placed at Tender Room, CRD Building, SSGC Head Office. Bids are to be delivered on or before closing time after which bid will not be entertained. If a bid is sent through courier, the same shall be delivered at least half an hour before scheduled opening time.
20. Price given in the Bid Form/BOQ is firm which shall take into account all relevant factors including discount / escalation given separately at the time of bid opening will not be considered.
21. The bidders are required to fill form SSW-05 (if deemed required) and submit with the bid.

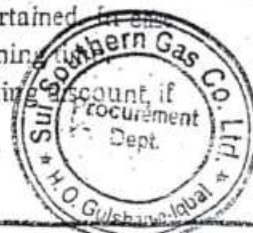

SECTION-II**INSTRUCTIONS TO BIDDERS (B)****1. Escalation**

It may be clearly understood that this tender does not contain a price variation clause and, therefore, all unit prices quoted shall be firm and irrevocable and shall not be subject to escalation on any account, whatsoever.

2. Bid Instructions

The bid shall be prepared in accordance with the following instructions:

2.1 Examination

Bidders shall visit/inspect the Work sites and shall fully acquaint themselves with the nature and requirements of Work, form and nature of sites, access to sites, availability of materials, weather, law and order and local conditions etc. before submitting their bids. **Submission of the bid shall be prima facie evidence that the Bidders have fulfilled this requirement.**

2.2 Clarifications

Each Bidder shall be deemed to have satisfied himself before submitting as to the correctness and sufficiency of its tender/offer and the rates quoted, which rates shall cover all its obligations under the Contract and all matters and things necessary for proper completion and maintenance of the Work. The Bidder may submit questions/queries regarding these documents to the Company in writing within a period extending upto 10 (ten) days after issuance of the tender enquiry. Replies shall be issued to all Bidders in writing and will be on record as addenda to the ensuing Contract. The Company will not be responsible for verbal clarifications. The bid submission time will however not be extended on this account.

2.3 Validity

Bids shall remain valid for acceptance for a period of **One Hundred and Twenty (120) days** from the date of bid opening. If the last date falls on a holiday, the validity will be extended to the first Company working day thereafter.

2.4 Cost of Preparation of Bid

Bidders will not be reimbursed for costs of any kind, whatsoever, incurred by them in connection with the preparation and the submission of their bids.

2.5 Bill of Quantities and Rates

The quantities specified in the Bill of Quantities (BOQ) are estimated and are intended to serve only as a guide to the Bidders. Payments shall be made on the basis of actual work quantum as measured. No claims shall be entertained on account of increase or decrease in the scope of work. The Bidders shall ensure that their bids are not front-end loaded, which may lead to rejection of their bids.



2.6 Sub-Contracting

The Bidder shall include a list of works which he intends to sub-let to sub-contractors. Sub-contractors proposed by the Bidder are subject to Company's approval.

2.7 Bid Documents

Bidders shall note that the tender documents including plans, drawing and specifications, furnished for tendering purposes are not to be used for any purpose other than tendering on this specific job and shall not be reproduced without the written permission of the Company. All such documents issued for tendering shall be returned with the bid duly stamped.

2.8 Organization Chart

An Organization chart proposed for the conduct of the Work shall be submitted after issuance of LTP (if required). The chart shall clearly show permanent members of the Bidders supervisory staff that the Bidder proposes to deploy on the work sites for the performance of the Work.

2.9 List of Equipment

The Bidder shall submit after issuance of LTP (if required), a complete list of equipment proposed to be used in carrying out the Work including make and type of all such equipment.

2.10 Time Schedule

The Bidder shall submit after issuance of LTP (if required), a detailed work programme in the form of a bar chart showing planned schedule of various activities required to complete the entire work (as per Scope of Work) within the stipulated completion period by deploying adequate manpower.

2.11 Additions, Deletions and Amendments

The Company reserves the right to add, to delete from and/or amend the work defined in Scope of Work/BOQ as deemed necessary before or after the execution of the contract. All such additions deletions and amendments shall only be authorized in writing by the Company's representative.

2.12 Signing Authority

Bidders shall return all tender documents (including drawings) duly signed on all pages by an authorized representative of the Bidder and shall also carry official stamp of the Bidder's firm.

2.13 Postal Address

The Bidder shall give below office telephone, telex and fax numbers including complete postal address at which correspondence may be sent and all notices may be legally served in connection with his bid and/or ensuing contract with the successful Bidder.



Telephone Nos: _____

Telex No: _____

Fax No: _____

Address: _____

2.14 Disqualification/Rejection of Bids

Failure to comply with any instruction in the tender documents would render the bid liable to disqualification and rejection.

2.15 Unit Work Rates

If the bid of the successful bidder is seriously unbalanced in relation to SSGC estimate of the cost of work to be performed under the contract, the SSGC may require the bidder to produce detail price analyses for any or all items of the Bill of Quantities to demonstrate the internal consistency of those prices with the construction method and schedule proposed. After evaluation of price analyses, the SSGC may require that the amount of Performance Bond set forth in the tender document be increased at the expense of successful bidder to a level sufficient to protect the SSGC against any and all Financial Loss in the event of default of the successful bidder under the contract.

2.16 Check List

Bidder shall, interalia, ensure the following before submitting the bid:

- All pages of the bid including drawings have been signed and stamped.
- Bid Bond for the specified amount has been enclosed.
- List of equipment and detailed work programme required under 2.9 & 2.10, Section II, is enclosed.
- Postal address, telephone, telex and fax Nos. (If available have been given in Clause 2.13, Section II).
- Total amount of Bid has been mentioned in 9c, Section VII, Tender Form.
- Duly authorized representative has signed (along with witness) at the end of Tender Form, Section VII.



SECTION-III

SCOPE OF WORK

Sui Southern Gas Company Limited (SSGC) intends to execute the installation of 80 mm thick CC paver blocks with a compressive strength of 6000 PSI in the Industrial Area of Karachi Terminal. The work includes dismantling and removing the existing cement concrete (CC) flooring where required, preparing the sub-base by laying 1:3:6 concrete wherever necessary to achieve and maintain the required finished floor level, and supplying and installing new 80 mm CC paver blocks with proper compaction, alignment, and finishing in accordance with the specified requirements. Further details and quantities are provided in Section VIII (BOQ).

The Contractor shall supply all finances and arrangement for manpower, machinery and material for the execution of the Work.

Contractor shall ensure safe and proper execution of the construction work with proper and sufficient material, machinery/equipment and adequate manpower and shall complete the work within the Scheduled Time.

“Make” of following Item / Materials shall be as specified hereunder:

Civil Works

- | | |
|---------------------|---|
| 1. Cement (OP / SR) | Lucky, Falcon or Equivalent |
| 2. Fine Aggregates | To be approved by the Company |
| 3. Coarse Aggregate | To be Approved by the Company |
| 4. Khaka | To be Approved by the Company |
| 5. CC Paver | EnviCrete, MagnaCrete or equivalent to be approved by company |

The Company's representative shall reject all the above shall be of first/prime quality; inferior or No.2 quality of any material. The Contractor shall remove such rejected material immediately from site as and when instructed by the Company's representative.



Ghulam Ali Mahar

Ghulam Ali Mahar
General Manager
Projects & Construction Dept.

13
Heavily
CE out
P&C



SECTION-IV**SPECIAL CONDITIONS OF CONTRACT****1. Representative of the Company**

The Representative of the Company for the purpose of this contract would be
Mr. Ghulam Ali Mahar GM (P&C)

2. Signing of Agreement

Formal signing of agreement shall be completed as soon as possible. However, the firm shall mobilize/commence work after issuance of Letter to Proceed. Formal agreement/contract would be made on stamp paper of value at the rate of Rs. 0.35 per hundred rupees of the value of contract. The stamp duty would be borne by the engineering firm.

3. Completion Period

The entire work shall be completed within **Three (03) months** from the issuance of Letter to proceed, which in case of work exigencies could be issued prior to signing of formal agreement.

4. Liquidated Damages

The rate of liquidated damages shall be **0.1% percent** of the delayed / remaining work for each day of delay and shall be capped to a maximum of **Ten (10%) percent** of the final contract value.

5. Certificate of Substantial Completion of Work

As soon as the Work shall have been substantially completed and corrected and shall have satisfactorily passed any test that may be prescribed by the Contract, the Contractor shall give the Company a notice of completion calling on the Company to inspect the works, and after inspection the Company shall grant a certificate of substantial completion and period of maintenance of the works shall commence from the date of such certificate provided that the Company may give such a certificate with respect to any part of the works before the completion of the whole of the works and shall upon the written application of the Contractor give such certificate with respect to any substantial part of the Work which has been completed to the satisfaction of the Company and occupied or used by the Company and when any such certificate is given in respect of a part of works, such part shall be considered as completed and period of guarantee and maintenance of such part shall commence from the date of such certificate. However, it shall be a condition precedent to the issue of certificate of "Substantial Completion" that the Contractor shall indemnify the Company against any failure by the Contractor to have carried out and completed the works in accordance with the Contract and shall warrant that the works are completed in every respect and conform to the Contract.

6. Final Completion Certificate

The Contract shall not be considered as completed until a final certificate have been issued by the Company's stating that the works have been completed corrected and maintained to satisfaction provided the Contractor has rectified all the defects mentioned in the "Punch list of Defects" to the entire satisfaction of the Company's representative. The final certificate shall be given by the Company after expiration of the period of maintenance or if different period of maintenance shall become applicable to different parts of the works the expiration of the last of such period and full effect shall be given to this clause notwithstanding any previous entry on



the works or the taking possession working or using thereof or any part thereof by the Company. The retention money of the Contractor shall be refunded after satisfactory completion of maintenance period and after issuance of final completion certificate.

7. Monthly Deduction

Monthly deduction of **Rs. 25,000** per month shall be made in case Contractor/firm fails to deploy agreed / specified full time Site Supervisor.

8. Performance Bond

The performance bond shall be in an amount equal to **Five (05%) percent** of the bid value / contract value and it shall be submitted within **10 days** after issuance of the Letter of Intent before signing of the Agreement/Contract within the stipulated time. The performance bond shall be released after the satisfactory completion of the work and issuance of substantial completion certificate.

9. Security Arrangement at Site

The firm/contractor shall be responsible to arrange all security and safety measures for staff and equipment required during undertaking the detailed engineering survey work & geotechnical investigation.

10. Maintenance Period

The maintenance period will be **Six (06) Months** after the issuance of Substantial Completion Certificate by the Company.

11. Retention Money

The retention money shall be equal to **Five (05%) percent** of the certified value of work which would be released after the maintenance period and rectification of punch list defects, to the satisfaction of the Company.

12. Mode of Payment

Payment against Running / Final bill shall be made to the Contractor by the Company as per actual executed quantities.

13. Disqualification / Blacklisting

The Company reserves the right to implement the clauses as per rules defined in PPRA rules. The decision in this regard will be firm, final and binding on all bidders.

14. Survey Equipment

The contractor/firm shall provide all the required survey equipment at site. The survey instrument / equipment shall be in good condition and shall be available at site for use by the Company.

15. Quality of Cement

Cement shall be procured from the approved local factories only complying with B.S. 4027. Imported cement shall not be used under any circumstances.

16. Fine Aggregate / Coarse Aggregates (Complying with BS 882)

i) Approved quality of sand shall be used as fine aggregates.

ii) Well graded crush stone (3/4" and down) of approved quality shall be used as coarse aggregates.



17. Water and Electricity

Water & electricity requirement for all purposes shall be arranged by the firm/ contractor. Only sweet water complying with ASTM-D 596 shall be used for construction works.

18. Quality of Material, Workmanship and Tests

All material and workmanship shall be of respective kinds described in the contract (drawings, sketches/BOQ/specifications/scope of works, etc.) and in accordance with the Company instructions and shall be subjected to tests from time to time as the Company may direct. **There will be no compromise on the quality of workmanship or material.** The firm/contractor shall provide such assistance, instruments, machines, labor and materials as are required for examining, measuring and testing any work and the quality, weight or quantity of any material used. The Contractor/firm shall supply samples of materials before incorporation in the work for testing and/or approval as may be selected and required by the Company. All samples shall be supplied by the Contractor/firm at his own cost and the cost of carrying out all such tests shall also be borne by the Contractor/firm.

In order to ensure quality of construction the Company (besides carrying out other tests as required under the contract) may carry out chemical tests to find out the ratio of cement and aggregate for the mortar or concrete used in the work. This shall also be at Firm/ Contractor's cost.

Contractor shall be responsible to follow all the SOPs regarding Quality and HSE and will be sole responsible to fill the quality inspection plan and follow.

19. Damage to Property and Persons

The firm/contractor shall, except if and so far as the Contract provides otherwise, indemnify and keep indemnified the Company against all losses and claims for injuries or damage to any persons or property whatsoever arise out of or in connection with or in consequence of the construction and maintenance of the works and against all claims demands, proceedings, damages, costs, charges and expenses whatsoever in respect of or in relation hereto.

20. Site Visit

The bidders are advised to visit and examine the Site of Works and its surroundings and obtain for themselves on their own responsibility all information that may be necessary to get clarity regarding scope of work/ BOQ for preparing the bid and entering into a contract for construction of the subject works. All cost in this respect shall be at the bidder's own expense.

21. Health Safety Environment (HSE)

The firm/Contractor will follow the Health, Safety & Environmental conditions as mentioned in Section-X "HSE Manual". The Firm/Contractor shall also deploy a full time qualified and experience safety manager for strict compliance to company's HSE policy. To ensure the safety of workers, utmost care shall be taken while cementing broken glass and installing razor wires onto the boundary walls.

22. Issuance of Revise Letter to Proceed (LTP)

If site will not be handed over to contractor/firm by the company due to non-clearance of site after issuance of Letter to Proceed (LTP), then revise LTP will be issued to the contractor/firm on written request of contractor. Further Revise LTP will only be issued if delay of handing over site is attributed towards company.



23. Provision of Mobile Phone Facility

Contractor will provide mobile phone with internet (Mobile data) facility to his supervisor at site in order to maintain 24 hours contact with Engineer-Incharge during the execution course of the project. And ensure that site supervisor timely provide pictorial progress of each activity to the Engineer Incharge.

24. Daily Progress Report

Contractor is responsible to maintain Daily Progress log at site and record all the details of daily executive work activities, issues related to site, detail of manpower and work done. Contractor will also submit weekly progress report along with the signed copies of Daily progress log to the Engineer Incharge.

NOTE:

- In case of any conflict between Special Conditions & General Conditions of the contract, the Special Conditions of the contract will govern.



Section - IV
Special Conditions of Tender Document
Tender Enquiry No. SSGC/SC/

Note: In case of any conflict between special conditions of Tender Document and any other terms & conditions, the Special Conditions of Tender Document will govern / prevail.

- 1- Contractor to submit the following within 15 days after issuance of Letter of Intent (LOI).
 - a. Performance Bank Guarantee
 - b. Stamp Papers
 - c. Insurance Policy
 - d. Any other Document as mentioned in the LOI
- 2- Formal contract will be made on Non-Judicial stamp paper of value @ Rs 0.35 per hundred rupees of contract value, as per prevailing rate by Government of Sindh & Balochistan. The stamp duty will be borne by the contractor and also submit the copy of challan of stamp paper. **Further as per Government of Sindh Board of Revenue notification NO.CIS/SWB/BOR/R&T-17/2022-808 dated 08-06-2022 all judicial and non-judicial stamp paper of the denomination of rupee five hundred and above shall be exclusively on e-stamp.**
- 3- All kinds of Government Taxes, Duties and Levies against any item of the contract, shall entirely be the responsibility of the Contractor. Income Tax will be deducted as per applicable Law under the prevailing Government Rules. Rate of Income Tax deduction in relation to submission of Income Tax certificate from the Contractor should also be stipulated.
- 4- Bank Guarantee (Bid Bond Guarantee/Performance Bank Guarantee) will be made on Non-Judicial stamp paper at the prevailing rate as specified by the respective Provinces. Further the bidder/contractor submitting the Bid Bond guarantee/Performance Bank guarantee being prepared by the State Bank's schedule banks should ensure that there should be no deletion/insertion/alteration/modification of any terms in the Bid Bond/PBG guarantee format as given in the tender document or else bid will be liable for rejection.
- 5- If the letter to proceed (LTP) by user deptt. is not issued within six months after issuance of letter of intent (LOI), both the parties are at liberty to terminate/revoke the LOI without any claim of loss or damage to the other party.
- 6- The completion period of the said work shall start with effect from the issuance of Letter to Proceed, which in case of work exigencies could be issued prior to signing of formal agreement.
- 7- In case of services and works tenders:
Bids determined to be substantially responsive will be checked by the Procuring Agency for an arithmetic error. Errors will be corrected by the Procuring Agency as follows;
 - a. Where there is a discrepancy between the amounts in figures and in words, the amount in words will govern ; and
 - b. Where there is a discrepancy between the unit rate and the line item total resulting from multiplying the unit rate by the quantity, the unit rates as quoted will govern, unless in the opinion of the Procuring Agency there is an obviously gross misplacement of the decimal point in the unit rate, in which case the line item total as quoted will govern and the unit rate will be corrected.
- 8- The bidder shall fill in rates and prices for all items of the works / services described in the BOQ. Item against which no rate or price is entered by a bidder will not be paid for by the Procuring Agency when executed and shall be deemed covered by rates and prices for other items in the BOQ. **Any Bidder who change / amend the BOQ or Price Schedule (description, Quantity, UOM etc.) will render the bid as conditional bid and will be liable for rejection.**
- 9- **Method For Submission of Bid Bond (Under Single Stage Two Envelope Bidding Procedure):**
In case of Single Stage Two Envelope Tenders the fixed bid bond as per clause#09 of General Terms & Conditions to be placed in the Technical Proposal. However, if the bid bond is placed in the financial proposal will also be considered. Without submission of bid bond (either in Technical proposal or financial proposal) the bid will be rejected.
- 10- Bid bond submission (2%) of the bid amount as mentioned in the clause 9 of General Terms & Conditions, to be treated as null & void, however other contents of clause 9 will remain unchanged. The submission of fixed amount of Bid security is appearing in the Schedule of Requirement/Bid Form.



- a) All the bidders are advised to furnish fixed bid security (Original Instrument) as per amount appearing in Schedule of Requirement/Bid Form, failing which their bid will be rejected.
- b) The submission of fixed amount of bid security is also mandatory for all the bids valuing Rs.500,000/- or less.
- c) The word lowest bidder or the lowest evaluated bid has been substituted to read as **most advantageous bid**.
- 11- Bid shall remain valid for acceptance for period of (120) days from the date of public opening of the bids & Bid Bond validity is for 150 days.
- 12- In case the local agent requires to offer bid form more than one Principal / Manufacturer, it is mandatory to purchase separate tender document for each Principal / Manufacturer, failing which the bid submitted with the original tender document will only be accepted and the bid with photocopy of tender document will be rejected.
- 13- **Blacklisting Mechanism of Suppliers and Contractors and their Local Agent:**
Black listing mechanism is attached separately in the tender documents which will become an integral part of Tender Documents and now be followed / enforced in true letter & spirit and **supersede the Black listing terms as mentioned in the General Terms & Conditions.**
- 14- Original counter slip of token which is issued with tender document to be attached on the TOP of envelope at the time of bid submission"
- 15- The **Successful Contractor(s) / Supplier(s) / Consultant(s)** shall submit a copy of Professional Tax Certificate with their Invoices / Bills failing which the payment will not be released.
- 16- **Contracts of Contractors**
In the event the contractor is not willing to extend the CONTRACT for further term(s) / Period(s) under the same terms & conditions and the quoted price as defined in the bid documents, the contractor is liable to intimate in writing to SSGC at-least 3 (Three) months in advance prior to completion of the existing contract term / period, failing which, action will be taken as per tender terms.
- 17- **Insurance**
In addition to the Clause 22 –**Insurance**, of General Term and Condition, when The **Successful Contractor(s) / Supplier(s)** will submit Insurance Policy to SSGC, the Insurance Company (policy issuer) should be registered with SECP, otherwise the insurance policy will not be considered / rejected at contractor's risk and cost. The insurance coverage period will be according to the work completion period as mentioned in the contract / tender documents.
- 18- **Fixed Bid Security – Alternative Bid**
A bidder cannot submit two bids/offers with a single fixed bid security/pay order. However, the alternative bids/offers with separate fixed bid security/pay order can be accepted, failing which the bids will be liable for rejection.
- 19- **Bid Bond & PBG (Performance Bank Guarantee) for Proprietary Tenders**
In case of proprietary Tenders, the Bid Bond & Performance Bank Guarantee (PBG) are not required / Applicable.
- 20- SSGC will not pay invoices if they are turned in after 6 months of work completion / material delivered.
- 21- It is mandatory for the bidders to follow all the terms and conditions given in the tender documents without any addition / deletion / amendment and submit the bid accordingly. Therefore, in this context, the bidders are requested not to give their own terms and conditions as it tantamount towards the conditional bid. Otherwise their terms and conditions will not be considered and the Purchase Order / Contract will be awarded based on only as per SSGC tender terms and conditions.
- 22- The bidders/contractors are required to provide their only one Bank Account number (IBAN number) on the 'FORM-X' attached duly signed & stamped as one time information, which shall be firm (not changeable) for all the future payment transactions.
- 23- **Payment:**
The supplier after delivery of goods and its acceptance shall submit invoice to Finance Department of the Company, containing following information i.e.
- Purchase order No. & date
 - Items
 - Quantity
 - Price
 - Invoice value
 - Point of delivery
 - Delivery challan indicating delivery date, etc.
 - Supplier(s) are required to submit signed and stamp acknowledgement slip, Sales Tax return,



Annex "C" & Annex "I" (whichever applicable) in which Sales Tax (of relevant Sales Tax invoice) is paid. Payment will be made within 30 days of completion of stated requirements.

24. In case the insurance policy submitted by the contractor is expired during the execution of job, it is the responsibility of the user department to coordinate with the contractor to get it renewed/updated till the period the job is completed/commissioned.

In case the job is not completed within the given time as per tender terms and the insurance policy submitted by the contractor expires, the contractor is liable to get this insurance policy renewed / updated immediately till the period of the job is completed / commissioned as per tender terms failing which the contractor will be responsible for any loss to SSGC.

25. Bidders can quote their rates on both i.e. Schedule of Requirement/Bid Form as well as Bill of Quantity (BoQ)

26. Subsequent to the issuance of LOI, successful bidder has to submit 10% Performance Bank Guarantee of the contract value unless and until specified in the tender document.

27. Company reserve the right to award the Purchase Order /LOI to most advantageous bidder.

28. As per SRO 592(I)/2022 of PPRA Regulations, for Procurement Contracts/Purchase Orders worth of Rs. 50 million and above, bidders/contractors are required to submit the Beneficial Owner's Information for Public Procurement Contracts/Purchase Orders (Annexure-I).

29. Bidder will be blacklisted and henceforth cross debarred for participating in respective category of Public Procurement proceedings for a period of (not more than) six months, if fail to abide with a bid securing declaration (which is an integral part of tender document), however, without indulging in corrupt and fraudulent practices, if in breach of obligation(s) under the Bid conditions:

a) The bidder have withdrawn or modified their bid during the period of bid validity as specified in the tender terms.

b) Having been notified of the acceptance of bid by procuring agency during the period of bid validity (i) failure to sign the contract or accept purchase order (ii) fail or refuse to furnish the performance security or to comply with any other condition as mentioned in the tender document.

30. Wherever the "Rate Only" is mentioned (either on BOQ or anywhere in tender documents) the same shall only be applicable not exceeding 15% of the original procurement for the same items as given in the BOQ for package basis. In case the requirement is on item wise basis (not package basis) then not exceeding 15% of the original Procurement for the same items (on item wise basis) as given in the BOQ.

31. **Lots:** In case when the tender is floated on LOT basis, following clauses to be applied:

a) The bidder(s) are essentially / mandatorily required to submit fixed bid bond as mentioned in the bid form/BOQ/Invitation to Bid. Separate fixed bid bond to be submitted against each individual LOT and its validity to be 150 days at the time of opening of technical proposal.

b) Evaluation for each LOT will be carried out separately. Each LOT will be awarded separately.

32. For open competitive bidding if the most advantageous bidder is new local manufacturer, 10% trial order will be placed and remaining 90% order will be awarded to the next most advantageous bidder at their own quoted rates.

33. Redressal of Grievances And Settlement of Disputes:

- Any bidder feeling aggrieved by any act of the procuring agency after the submission of his bid may lodge a written complaint concerning his grievances within seven days of announcement of the technical evaluation report and five days after issuance of final evaluation report.
- In case, the complaint is filed against the technical evaluation report, the GRC shall suspend the procurement proceedings.
- In case, the complaint is filed after the issuance of final evaluation report, the complainant cannot raise any objection on technical evaluation of the report. Provided that the complainant may raise the objection on any part of the final evaluation report in case where single stage single envelope bidding procedure is adopted.

34. All the bidders are allowed to participate in the subject procurement without regard to nationality/origin, except bidders of some nationality/origin, prohibited in accordance with policy of the Federal Government. Following countries are ineligible to participate in the procurement process:

- India
- Israel



35. In Open Competitive Bidding Procedure where the quoted price is less than Rs. 500,000/- the Bid Bond will be retained in lieu of PBG.
36. In case the Bid Bond is not required, the bidder must submit the Form of Bid-Securing Declaration attached with the Tender Document else the Bid will be liable for rejection.
37. All Tenders floated through EPADS are to be governed by S.R.O. 296(I)/2023 dated: March 8, 2023 "E-Pak-Procurement Regulations 2023". In case of any conflict between SSGC Tender Terms / Instructions to Bidders and the PPRA EPADS Rules, the S.R.O. 296(I)/2023 will prevail.



SECTION - 1

General Terms & Conditions**I. Definitions and Interpretation:**

1.1

In these tender documents (as hereinafter defined) the following words and expressions shall have the meaning hereby assigned to them except where the Tender requires otherwise.

- a) **Company** means the Sui Southern Gas Company Limited; a Company registered under statutes of Pakistan and includes any successors-in-interest or assignees.
- b) **Engineer** means the Engineer(s) nominated by the Company to look after and supervise the Work.
- c) **Representative of the Company** means a duly authorized person appointed by the Company or as specified in the "Special Conditions of the Contract" to perform the assigned duties.
- d) **Bidder** means any person or persons, firm or company bidding for the Work.
- e) **Contractor** means the persons, firm or company whose Tender (as hereinafter defined) has been accepted by the Company and includes the Contractor's representatives, sub-Contractors, successors and permitted assignees (Prior to the execution of the Contract the word "Contractor" also means a Tenderer or Bidder submitting a proposal in accordance with the Tender Documents).
- f) **Agent or Representative** means person(s) appointed by the Contractor to perform duties as set forth in the Contract.
- g) **Laborers/Workmen** means such laborers/workmen and staff as may be employed by the Contractor for purpose of carrying out the Work.
- h) **Sub Contractor** means any firm or person having a direct Contract with the Contractor. Nothing contained herein however, shall be deemed or be construed to impose upon the Company, any obligation, liability or duty to a sub-contractor or to create any contractual relation between any sub-contractor and the Company.
- i) **Work** means whole of the Works / Services or part thereof to be executed in accordance with Tender / Contract documents, whether temporary or permanent and whether original, altered substituted or additional.
- j) **Contract Documents** shall consist of duly executed Articles of Agreement, the Tender Documents and the Tender submitted by the successful Bidder including modifications thereto incorporated in the documents before and after the execution of the Contract.
- k) **Contract Price/Value** means the sum named in Schedule of (SOR) / BOQ subject to additions thereto or deductions there from as may be made under the provisions hereinafter contained.
- l) **Plant** means all machineries, equipment, materials, appliances or things of whatsoever nature required in or about the execution, completion or maintenance of the Work, but does not include such equipment, materials, appliances or things intended to form part of the permanent Work.
- m) **Temporary Works** means all temporary works of every kind required in or about the execution, completion or maintenance of the Work.
- n) **Drawings** means the drawings referred to in the Contract documents and any modification of such drawings.
- o) **Location** means the land and other places on, under in or through which the Work is to be executed or carried out and other lands or places provided by the Company for the purpose of the Contract.
- p) **Approved/Approval** means approved/approval in writing by Company's representative or as specified in "Special Conditions of Contract".
- q) **Tender/Bid** means the offer tendered by the Bidder for the Work governed by the Contract.
- r) When the terms Acceptable, Satisfactory, Proper, or other such general qualifying terms are used in the Contract, it shall be understood that reference is made to be sole ruling and the sole judgment of the Company.
- s) The Word Equivalent or Equal where used in these documents in the general sense shall not mean Similar but shall mean "Conforming to, Like, of Kind/Quality and Function". "Proprietary Items" and "Trade Names" are used for the purposes of establishing a standard of "Kind, Quality and Function" and "Equipment" items, articles, things or materials will be approved, if held to be "Equivalent" by the Company.
- t) **Approved Banker** wherever occurring in this Contract shall mean a Scheduled Commercial Bank operating in Karachi and acceptable to the Company.

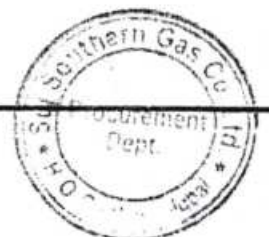

- u) **Specification(s)** means the standard codes of practice and other specifications issued with the Tender and any notification such as specifications approved in writing by the Company and other specifications as may from time to time be furnished or approved in writing by the Company.
- v) **Month** means calendar month of the Christian era.
- w) **Time Schedule** is a graphical illustration of the time span of various Work activities defining starting and completion dates.
- x) **Bonds** mean Bid Bond, Performance Bond or Bank Guarantee and other instruments of security furnished by the Bidder of his surety in accordance with the Tender/Contract.
- y) **Completion Date** means the date on which the Work has been completed in accordance with the Contract so that it can be utilized for intended purpose.
- z) **Day** means a day of 24 hours mid night to mid night.
- aa) **Completion Period** means the time allowed for the execution of the Work.

1.2 Words importing the singular only also include the plural and vice-versa where the Contract so requires.

1.3 The marginal headings or notes in these Conditions of Contract shall not be deemed to be part thereof or be taken into consideration in the interpretation or construction thereof or of the Contract.

1.4 If there is any conflict between the Special Conditions and the General Conditions, the Special Conditions shall modify, supplement and supersede the General Conditions.

2. **Examination:**

Bidders shall visit/inspect/examine the Work & Location and shall fully acquaint themselves with the nature and requirements of Work/Services, access to Work/Location, availability of materials, weather, law and order and local conditions etc. before submitting their Bids. Submission of the Bid shall be prima facie evidence that the Bidders have fulfilled this requirement and shall be binding upon him.

3. **Conflict between Drawings/Specifications/SOR:**

In case of any conflict between drawings/specifications, SOW/TOR and SOR/BOQ, with regard to the quality of any item, the Contractor / Consultant shall base his quotation for the better quality. In case of any deficiency in the drawings/details, the Contractor / Consultants shall seek clarification from the Company. Submission of Bids/rates on the basis of incomplete drawings/details shall be Contractor / Consultant's sole responsibility.

4. **Additions, Deletions:**

The Company reserves the right to make addition (Upto 15 %) and delete the quantity from the Work defined in SOW/TOR/SOR/BOQ as deemed necessary before or after the execution of the Contract. All such additions and deletions shall only be authorized in writing by the Company.

5. **Schedule of Requirement:**

The quantities specified in the SOR/BOQ are estimated and are intended to serve only as a guide to the Bidders. Payments shall be made on the basis of actual Work quantum done as measured. No claims or adjustments shall be entertained/allowed on account of increase or decrease in the Scope of Work which has not been duly authorized by the Company through the issue of change orders as stipulated in the relevant provision.

6. **Rate:**

The Bidder shall quote all item rates and lump sum prices as shown in the "SOR/BOQ". Bidders shall fill in the rate / price for each item in the SOR/BOQ. In case of any discrepancy between item rate and the amount, the quoted item rate will prevail. The quantities given in the SOR/BOQ are estimated ones and are subject to variations. That is, there could be increase or decrease. Nevertheless, the item rates quoted by the Bidder shall remain fixed and no escalation whatsoever shall be permissible. The rates / prices quoted by the Bidder shall be workable. The Bidder shall be required to furnish a complete rate analysis of any item in the SOR/BOQ as considered necessary, by the Company.

7. **Escalation:**

It may be clearly understood that this tender does not contain a price variation clause and therefore, all unit prices quoted shall be firm, irrevocable fixed and valid until completion of the Contract and will not be subject to variation on any account.

8. **Validity:**

Bids shall remain valid for acceptance for a period of (120) days from the date of bid opening. If the last date falls on a holiday, the validity will be extended to the first Company working day thereafter.

9. **Bid Bond (Earnest Money):**

The Bidder is required to furnish Bid Bond strictly in accordance with the prescribed format, in the form of a Pay Order, Demand Draft or Bank Guarantee issued only by a scheduled commercial bank operating in Karachi, for an amount fixed bid bond as specified of tendered Work / Services quoted by the Bidder in favor of Sui Southern Gas Company Limited. No Bid shall be considered without a Bid Bond and no cash or cheque or a guarantee issued by an insurance company shall be accepted.

The Bid Bond shall remain valid for a period of 150 days from the date of Bid opening. Bid Bonds of the unsuccessful Bidders shall be returned as soon as practicable, The successful Bidder's Bid Bond shall be retained by Company until execution of a Contract for the Work / Services defined in these documents and the submission of a Performance Bond prior to the execution of Contract.

In the event that the successful Bidder refuses or fails to provide (PBG) and Stamp papers for contract within fifteen (15) days of the issuance of a Letter of Intent, Company shall be at liberty to forfeit the Bid Bond.

In the event of the bid bond validity falling short of the prescribed period of 150 days as the case may be either (i) due to extension in the bid submission date or (ii) where so required by the procuring agency, than in such an event it shall be mandatory on the bidder to extend the bid bond validity up to 150 days within 30 days of the opening of technical proposal / bid, and / or where so required by the procuring agency.

In case when bidder submit alternate bids a separate bid bond for each bid is required otherwise bid will be liable for rejection. In case of Single Stage Two Envelope bidding system (bid bond will be enclosed with "Financial" bid, unless and until specified separately in Tender terms).

The bid bond may be forfeited if a bidder withdraws the bid during validity period specified by the bidder or if successful bidder fails to:

- Accept purchases order/LOI,
- Furnish performance guarantee in accordance with clause 10 of General Terms & Conditions,
- Extend Services as per requirement and completion Period.

10. Performance Bond:

The Bidder shall furnish a Performance Bond strictly (if the bid increases to Rs. 500,000/-) in accordance with the prescribed format in the form of a bank guarantee issued by a scheduled commercial bank operating in Karachi for an amount equivalent to FIVE (05) percent of the Contract value. Failure to furnish the performance Bond before execution of the Contract will entitle the Company to consider the Bidder as having abandoned the Contract and the forfeit the Bid Bond. The Performance Bond shall remain valid till after three (03) month of completion of the work.

The Company's right to recover damages from the Bidder for breach of Contract shall not be limited to the value of the Performance Bond. In the event of the Bidder failing to execute a formal Contract or to submit the Performance Bond in the manner aforesaid and in the period specified, the Company shall be entitled to appropriate the earnest money submitted by the Bidder with his tender without prejudice to its right to claim any further loss or damage which may result to it by reason of the aforesaid default of the Bidder as if Contract is actually executed for the purpose of such claims.

The Bidder shall extend the validity period of the Performance Bond for such period(s) as required for the Contract performance.

The performance bond of the successful bidder will be released after successful completion of work.

11. Retention Money:

The amount to be retained from payments shall be equal to the specified percent of certified value of Work which would be released after the maintenance period.

12. Completion Period:

Subject to any requirements as to completion of any portion of the Work before the completion of the whole of Work, the Work shall be completed within the specified completion period. The Work shall not be considered as completed until the Company has certified in writing that it has been completed. Should extra, altered or additional Work of any kind, or any other cause of delay, which in the opinion of the Company could not have been foreseen by the Contractor / Consultant requires extension in completion time, then on the written request of the Contractor / Consultant, the completion period as provided in the Contract shall be extended by the Company. All such extensions shall be allowed in writing by the Company's representative.

13. Signing / Execution of Contract / Agreement:

Formal signing / execution of Contract / Agreement shall be completed within fifteen (15) days of receipt of "Letter to Proceed". The Company shall prepare the Contract in accordance with the prescribed format (Contract Form, and Articles of Agreement) for the purpose and the successful Bidder shall be communicated the date and time by the Company for the execution of Contract.

The successful Bidder shall provide the stamp paper, of value at the rate of thirty five (35) paisa per every hundred Rupees or part thereof of the amount of the Contract, or at the prevailing rate as specified by the Government of Pakistan.



In case the agreement is executed for services i.e Janitorial, Canteen, Landscaping, Maintenance Contract etc.... will be for One year extendable for further Two terms of one year each unless specified in Special Term & conditions.

14. **Award / Evaluation Criteria:**

Company reserves the right to settle the final award of job to the technically compliant and lowest evaluated and commercially responsive bidder.

Evaluation may be carried out both on item or on group of items/single or multiple package basis depending upon the nature of requirement exclusively at the discretion of the company to ensure economic procurement.

15. **Commencement & Execution of Work:**

Notwithstanding any delay in the preparation / execution of the Contract the successful Bidder shall commence mobilization / preparations and under take the Work within (15) days after receipt of the Letter to Proceed.

The Contractor / Consultant shall prior to commencement of Work, obtain the written authority and instructions of the Company.

16. **Change in Orders:**

The Company may at any time, by a written notice to the Contractor / Consultant, make changes within the general Scope of Work of the Contract.

Upon notification by the Company of such change, the Contractor / Consultant shall submit to the Company an estimate of costs for the proposed change (hereinafter referred to as a change) within ten (10) calendar days of receipt of notice of the change, and shall include an estimate of the impact (if any) of the change on the completion date (s) under the Contract, as well as detailed schedule for the execution of the change, if applicable.

The Contractor / Consultant shall not perform changes in accordance with above, until the Company has authorized a Change Order in writing on the basis of the estimate provided by the Contractor / Consultant.

Changes mutually agreed upon as a change shall constitute a part of the Work under this Contract, and the provisions and conditions of the Contract shall apply to said change.

17. **Assignment:**

The Contractor / Consultant shall not assign, in whole or in part, its obligations to perform under the Contract except with the Company's prior written consent.

18. **Termination of Contract:**

The Company may decide to terminate the Contract in one of the following situations:

(i) **Termination for Default:**

The Company may, without prejudice to any other remedy for breach of Contract, by written notice of default sent to the Contractor / Consultant, terminate the Contract in whole or in part.

- (a) If the Contractor / Consultant fails to complete the contracted Works / Services within the time period(s) specified in the Contract or any extension thereof granted by the Company.
- (b) If the Contractor / Consultant fails to perform any other obligation(s) under the Contract.
- (c) If the Company during the completion period of the Contract has reason to believe that the Contractor / Consultant will not be able to fulfill the obligations under the Contract.

Prior to the exercising of any right by the Company to terminate the Contract, the Company shall issue notice to the Contractor / Consultant specifying the default(s) and the Contractor / Consultant shall submit an explanation within seven (07) days of receipt of such notice. If such explanation is not furnished within the stipulated time or if so furnished, is found to be unsatisfactory and / or the default(s) continues, the Contract may be terminated by the Company.

(ii) **Termination for Insolvency:**

The Company may at any time terminate the Contract by giving written notice to the Contractor / Consultant, without compensation to the Contractor / Consultant, if the Contractor / Consultant becomes bankrupt or otherwise insolvent. Notwithstanding the above such termination will not prejudice or affect any right of action or remedy which as accrued or will occur thereafter to the Company.



(iii) **Termination for Convenience:**

- a. The Company may by written notice sent to the Contractor / Consultant, terminate the Contract, in whole or in part, at any time for its convenience. The notice of termination shall specify that termination is for the company's convenience, the extent to which performance of work under the Contract is terminated and the date upon which such termination becomes effective.
- b. The Works that are complete and ready for Commissioning within thirty (30) days after the Contractor / Consultant's receipt of notice of termination shall be at the Contract prices and on the existing Contract terms. For the remaining Works, the Company can also opt to have any portion thereof completed and commissioned at the contract prices and on the other contract terms.

19. **Liquidated Damages:**

If the Contractor / Consultant fails to complete the Work or perform the Services specified in the Contract within the stipulated period / scheduled time specified in the Contract, the Company, without prejudice to any other remedies, shall deduct from the bills or any other due payments / guarantees, as liquidated damages, a sum equivalent to 0.1 % per day of the value the Contract, until actual completion of the Work or performance of the Services. However if delay of over 100 days takes place (i.e. equal to 10%), the Company reserves the right to terminate the Contract at the risk and cost of Contractor / Consultant. The liquidated damages shall also be applicable for the Works / Services terminated under Clause 16.

The payment of liquidated damages shall not relieve the Contractor / Consultant from performing and fulfilling all its obligations under the Contract and nor shall the rights and entitlements of the Company be affected or reduced in any manner.

20. **Force Majeure:**

The parties will not be considered to be in default in the execution of their contractual obligations or any of them to the extent that the execution of such obligations or any of them is delayed or omitted by cause of Force Majeure. Each party will advise the other party by written notice within 07 days of the occurrence of any such case of Force Majeure. The term Force Majeure employed herein shall mean acts of public enemy, wars (whether declared or not) invasion, hostilities, revolution, epidemics, riots (other than among the Contractor / Consultant's own employees) fires, floods, earth quake, commotion, disorder and other causes similar in kind to those herein mentioned, not under the control of either party, which makes the performance of this agreement unfeasible and which by the exercise of due diligence the party seeking excuse from performance is unable to overcome.

The Company shall not be liable to the Contractor / Consultant for any damage or loss caused by Force Majeure directly or indirectly.

21. **Safety of Employees and Works:**

The Contractor / Consultant shall be responsible to take all necessary precautions for the safety of employees on or off the Work, and shall comply with all applicable safety laws and codes to prevent accidents or injury to persons on about or adjacent to the places where the Work is being performed. All statutory rules, orders, regulation from time to time in force relating to taking and observance of all safety precaution governing or which might be deemed to be given during the execution and performance of the Work. The Contractor / Consultant shall comply with any and all personnel safety regulations. Any person of the Contractor / Consultant violating the safety rules shall be removed by the Contractor / Consultant from site and replaced without delay.

22. **Insurance:**

The Contractor / Consultant shall be responsible for obtaining a Contractor / Consultant's All Risk Policy (CAR) against risks to the Works and shall make good at his own cost, all losses or damages whether to the Works or to the lives, persons, whether under the workmen's compensation Act or Third Party Risk, or property of others from whatsoever cause arising out of or in connection with the works either during the progress of the works or during the period of maintenance provided by this Contract.

The Contractor / Consultant shall arrange insurance approved by the Company fully to cover workmen compensation and other claims arising out of sickness, injury or death of his personnel working at site and also to cover theft, loss of or damage to the Company's material in his possession and to indemnify the Company for third party claims for damage done or said to have been done to those persons or their property as a result of the Contractor / Consultant's activities on and off the site.



Insurance will be required where ever applicable:

Company's Address:

**GENERAL MANAGER (PROCUREMENT)
SUI SOUTHERN GAS COMPANY LIMITED,
2ND FLOOR, HEAD OFFICE, ST-4/B, B-14,
SIR SHAH SULEMAN ROAD,
GULSHAN-E- IQBAL,
KARACHI –PAKISTAN.**

Contractor / Consultant's Address:

23. Dispute Resolution:

If any dispute shall arise as to the interpretation of this Contract or any matter or thing arising there from, the same shall be settled as far as possible by way of amicable resolution. Failing such settlement, the dispute may be referred for arbitration to two Arbitrators, one to be nominated by each Party. The appointed Arbitrators shall before proceeding on the reference appoint an Umpire. The Award given by the Arbitrators or the Umpire as the case may be shall be final and binding on the Parties. The proceedings shall be governed by the Pakistan Arbitration Act, 1940 and any statutory modification thereof. The venue of arbitration shall be Karachi.

All costs of Arbitration shall be borne by the Parties themselves, unless otherwise ordered by the Arbitrator. Notwithstanding the existence of any difference or dispute, or the commencement or continuance of any arbitration proceedings, Works to be done or Services to be provided under this Contract shall not be suspended or discontinued by the Contractor / Consultant nor shall any payment be withheld by the Company except the difference of the amount in dispute, which is the subject matter of such proceedings.

24. Income Tax and Duties:

All kinds of Government Taxes and Duties (income tax, custom duties, etc.) also the provincial sales tax as per provincial law, against any item of the contract, shall be entirely the responsibility of the Contractor / Consultant. Income Tax will be deducted as applicable under the prevailing Government Rules. Rate of Income Tax deduction in relation to submission of Income Tax certificate from the Contractor / Consultant should also be stipulated.

All Foreign Service providers are required to obtain Advance Ruling from the Federal Board of Revenue (FBR) under Section 206A of the Income Tax Ordinance 2001 (Pakistan's Income Tax Law). The advance Ruling issued by FBR covers application of Income Tax Ordinance 2001 to Transaction proposed or entered in to Foreign Service Provider".

25. Payments:

Payment will be made within 30 days after completion of works.

The Contractor / Consultant shall submit to the Company during the execution of the Work on-account bills along with a statement / details of executed Work.

The rates and prices in such on-account bills and statement of Work shall be in accordance with those in the SOR/BOQ so far as such rates and prices are applicable and on the approved rates and prices for other items of Work. All payments against on-account bills shall be treated as provisional payments and will be subject to final adjustment.

The Company may withhold payment or on-account of subsequently discovered evidence, nullify the whole or part of any certificate to such extent as may be necessary to protect itself from loss on-account of:

- (a) Defective Work not remedied.
- (b) Claims filed or reasonable evidence indicating probable filling of claim.
- (c) Failure of the Contractor / Consultant to make payments properly to Sub-Contractor / Consultants.
- (d) Damage to another Contractor / Consultant.

When the grounds are removed payment shall be made for amounts withheld because of them.

Payments in respect of extra / additional Work will be made on the basis of the original Contract rates and the Contractor / Consultant will not be entitled to any extra compensation / payment including idle charges because of such delays.



The making and acceptance of the final payment after successful completion of Work shall constitute a waiver of all claims by the Company other than those arising from faulty Work appearing after final payment and of all claims by the Contractor / Consultant, except those previously made and still unsettled.

Supplier (s) are required to submit signed and stamped acknowledgement slip, Sale Tax return, Annex "C" & Annex "I" (whichever applicable) in which Sales Tax (of relevant Sales Tax invoice) is paid.

26. **Blacklisting of Suppliers and Contractor / Consultants:**

The company shall permanently blacklist or temporarily debar (at least for 6-months from participating in SSGC's tender proceeding) if, a supplier or Contractor / Consultant who either constantly fails to perform satisfactorily or found to be indulged in corrupt and fraudulent practices as defined below:

- 26.1 Corrupt and fraudulent practices" includes the offering, giving, receiving, or soliciting of anything of value to influence the action of an official/company.
- 26.2 If the supplier/Contractor / Consultant found responsible for the detriment of the company during proceedings of procurement/contract, process or its execution.
- 26.3 Misrepresentation of facts (by providing fake documents, concealing / mis-reporting facts pertaining to the bid) in order to influence the procurement process or the execution of the purchase order/contract.
- 26.4 Collusive practices among bidders (prior to or after bid submissions) designed to establish bid prices at artificial, non-competitive levels and to deprive the company of the benefits of free and open competitive.

27. **GOP's Obligation:**

The contract shall be governed by the Law of Pakistan. The Contractor / Consultant is obligated to comply with all regulations and ordinance in force or to be passed by the Government of Pakistan in connection with Labor legislation during the course of the work to be performed. Any additional financial charges on account of revision in minimum wages by GOP will be company's responsibility while the contract is in operation.

This contract embodies the entire understanding of the parties hereto on this subject and there are no commitment, terms, conditions or obligations, oral or written, express or implied, other than those contained herein.

28. **Late Bid:**

Sealed bids shall be mailed/submitted/dropped in tender box placed at Tender Room, CRD Building, and SSGC Head Office, In accordance to the time specified in invitation to bid & tender notice (which ever applicable), Bids are to be delivered on or before closing time after which all bids submitted after the time prescribed shall not be entertained and will be returned without being opened. In case bid is sent through courier, the same shall be delivered at least half an hour before scheduled opening time.

29. **Rebate / Discount:**

Unit rate (s) given in the Bill of Quantities shall take into account all relevant factors including discount if any. Discount given separately at the time of bid opening will not be considered.

30. **Joint Ventures:**

In the event that the bidder is bidding as a Joint Venture, the Company will require the joint venture agreement duly executed by the parties to the Joint Venture to be submitted with the bid. The joint venture parties shall also furnish an undertaking to be jointly and severally liable for all liabilities arising out of obligation under the Purchase Order / Contract. The, Joint Venture agreement of the parties must specify share of each partner and name of the lead partner along with their registration with the FBR, SST and BST as the case may be failure to specify these two narrations the joint venture agreement will not be entertained.

31. **Correction / Amendments in Quoted Price:**

Any overwriting in BOQ / SOR is not allowed. In case of type of any amendment / correction required in unit price / total amount the same has to be strikeout and re-written with corrected figures, properly signed & stamped out, in order to avoid an ambiguous bid.



SECTION-VI**TENDER FORM**

Sui Southern Gas Company Limited,
ST 4/B, Block 14, Sir Shah Muhammad Suleman Road,
Gulshan-e-Iqbal,
KARACHI.

Sui Southern Gas Company Limited
Laying of CC Paver Blocks at the Industrial Area, Karachi Terminal
Tender Ref No: CIV-TRANS-P&C 2K2560

Dear Sir,

1. Having examined the Site, Drawings, Conditions of Contract, Scope of Work and Bill of Quantities for the subject Work, I/We, the undersigned offer to undertake, complete and maintain the whole of the said Work in conformity with the contract terms the unit rates given.
2. I/We undertake, if my/our tender is accepted, to commence the Work within specified time after receipt of the letter of intent/letter to proceed/signing of contract, and to complete and deliver the whole of the Work contained in the contract within the period specified in the tender document.
3. If my/our tender is accepted, I/We shall provide an irrevocable bank guarantee of a Scheduled Bank (acceptable to the Company) to be jointly or severally bound with me/us in a sum specified hereunder and in Annexure II for the due performance of the contract.
4. I/We agree to abide by this tender for the period of 90 days from the date fixed for opening the same and it shall remain binding upon me/us and may be accepted at any time before the expiration of this period.
5. I/We agree to execute the Work in a manner satisfactory to the Company whose decision shall be final and without appeal on work methods, specifications, and quality of materials, equipment and workmanship.
6. I/We agree to supervise and furnish adequate engineering and supervisory staff, labour force, tools, plants, machinery and finances to perform the Work in time as specified in the agreed Time Schedule to ensure that all will be done in accordance with accepted international engineering standards.
7. Unless and until a formal agreement is prepared and executed, this tender together with the Company's written acceptance shall constitute a binding contract between us.
8. I/We understand that the Company is not bound to accept the lowest or any tender Received without assigning any reasons.
9. For ease of reference certain information and special stipulations applicable to the contract within the subject of the tender are set forth herewith:

Jau's

- a. Name of the Company : Sui Southern Gas Company Limited
- b. Name of Work : Laying of CC Paver Blocks at the Industrial Area, Karachi Terminal
Tender Ref No: CIV-TRANS-P&C 2K2560
- c. Amount of Bid : Rs. _____
(To be filled in by the Bidder)
- d. Retention Money : **Five (5%) Percent** of all payments made to the Contractor.
- e. Date of award of Work : Date of acknowledgement of Letter of Intent (LOI) by the Contractor.
- f. Mobilization Period : **Two (02) weeks** from the date of issuance of Letter to Proceed
- g. Value of Performance Bond : **Five (5%) Percent** of the Contract / Bid Value.
- h. Completion Period : **Three (03) months** from the date of Letter to Proceed with 02 weeks of mobilization period.
- i. Mode of Payment : As per Clause 12, Section-IV, and "Special Conditions" of Tender Enquiry.
- j. Maintenance Period : **Six (06) months** from the date of completion.
- k. Liquidated Damages : The rate of liquidated damages shall be **0.1% percent** of the final contract value for each day of delay and limited to a maximum of **ten (10%) percent** of the final contract value.
- l. Insurance : (CAR) Contract Value + 10%

In the name of _____

Dated this _____ day of _____ 2025.

Signature _____ in the capacity of _____

Duly authorized to sign the tender for and on behalf of _____

Witness

Signature: _____

Name: _____

Address: _____



Handwritten signature and text:
*3.
Khalid
CEM
P&C

SECTION VIII
Laying of CC Paver Blocks at the Industrial Area, Karachi Terminal
Tender Ref No: CIV-TRANS-P&C 2K2560

BILL OF QUANTITY

S.n	Description	Unit	Quantity	Rate	Amount
1	Cutting / Dismantling of Existing CC Floor Providing all material, labor, tools & equipment for dismantling / cutting existing Cement Concrete flooring up to a depth of 6" (Area marked in drawing) or wherever required to maintain / adjust the floor water level including disposing of all the debris from the site to municipality approve dumping site outside the company's premises complete in all respect as per drawing, BOQ, site requirement or as directed by engineer in charge.	Sft	1800		
2	1:4:8 Concrete Providing all material, labor, tools & equipment for levelling, dressing, mixing, placing compacting & curing minimum 2" thick concrete 1:4:8 concrete floor base (1 part OP Cement, 4 parts fine sand & 8 parts coarse sand) on dismantled floor (Area marked in drawing) or wherever required to provide the uniform base for CC pavers and maintain / adjust the floor water level complete in all respect as per drawing, BOQ, site requirement or as directed by engineer in charge.	Sft	1800		
3	Paver Block 80mm Providing all materials, labor, tools, and equipment for the supplying, laying, and fixing of 197 mm × 97 mm × 80 mm paver blocks, having a minimum compressive strength of 6000 PSI, of approved make and pattern, in natural cement color. The paver blocks shall be laid over a minimum 2-inch thick bedding layer of clean, washed sand (Khaka) with coarse to medium grading. The scope of work includes surface preparation, spreading and leveling of sand, placement of paver blocks, brushing of joints, mechanical compaction using a vibratory plate compactor, and fixing of paver floor edges with cement-sand mortar, complete in all respects, as per site requirements, drawings, and as instructed by Engineer-in-Charge.	Sft	12000		
Grand Total					

Note:

The contractor is advised to visit the site to verify all levels and site conditions prior to submitting their bid



Report Run by : DESKTOP-D30VR27
 Enquiry No. SSGC/SC/14231

TENDER ENQUIRY NO. SSGC/SC/14231

SECTION VII

SCHEDULE OF REQUIREMENT
AND
BID FORM

Sr. NO.	DESCRIPTION OF ITEMS / PART NOS. (1)	QUNATITY (3)	UOM (4)	TOTAL AMOUNT
1	<u>CIVIL WORKS</u> [1] SC012006 LAYING OF CC PAVER BLOCKS (12000 SFT) AT INDUSTRIAL AREA , KARACHI TERMINAL. (AS PER BOQ) <u>Delivery Schedule:</u>	1.00	Job	

Fix Bid Bond Amount in PKR: 60,000

NOTE :

- (i) The quoted unit price and corresponding total amount shall be inclusive of all duties & Taxes, excluding Sales Tax as per provincial laws.
- (ii) Incase of supply of material alongwith services GST will be exclusive of quoted rate of material.
- (iii) Bidders are essentially required for quote their rates on bid form / BoQ.
- (iv) Prices given in the bid form and BOQ shall take into account all relevant factors including discounts, if any. Discount given separately at the time of bid opening will not be considered.
- (v) Any Bidder who change/amend the BOQ or Price Schedule (description, quantity, uom etc.) will be render the bid as conditional bid and will be liable for rejection.

SIGNAUTRE OF BIDDER: _____
 NAME.....: _____
 NAME OF BIDDER....: _____
 STAMP.....: _____
 DATE.....: _____

(On Stamp Paper @ Rs.100 for first Rs.100, 000 and Rs.50 per subsequent Rs.100, 000 of Guarantee Value)

BID BOND FORMAT

Sui Southern Gas Company Limited,
ST-4/B, Sir Shah Muhammad Suleman Road,
Block 14, Gulshan-e-Iqbal,
Karachi.

Tender Enquiry No SSGC / SC /

Dear Sirs,

In consideration of Messrs _____ hereinafter called "The Bidder" having submitted the accompanying bid and in consideration of value received from _____ we hereby agree to undertake as follows:

1. To make un-conditional payment of Rupees _____ upon your return demand without further recourse, question or reference to the Bidder or any other person, in the event of the with drawl of the aforesaid Bid by the Bidder before the end of the period specified in the Bid after the opening of the same for the validity thereof, or if no such period to be specified within 120 days after said opening and or in the event that the Bidder within the period specified thereof, or if no period be specified with 15 days after prescribed forms are presented to the Bidder of signature the Bidder shall fail to execute such further contractual documents if any as may be required by the Company, or on the Bidders' failure to give the requisite Performance Bond as may be required for the fulfillment or resulting Contract with 10 days of the acceptance of the Bid.
2. To accept written intimation(s) from you as sufficient evidence of the existence of default or non compliance as aforesaid on the part of the Bidder and to make payment immediately upon receipt of the written intimation.
3. No grant of time or other indulgence to, or composition, or arrangement with the Bidder in respect of the aforesaid Bid with or without notice to us shall in any manner discharge or otherwise, however, affect this guarantee and our liabilities and commitments hereunder.
4. The guarantee shall be binding on us and our successors in interest and shall be irrevocable.
5. This guarantee shall remain valid upto _____.

Yours faithfully,

Note: Any extensions / amendments (in all guarantees/bonds) if required shall be made on stamp papers of Rs.50



(On Stamp Paper @ Rs.100 for first Rs.100, 000 and Rs.50 per subsequent Rs.100, 000 of Guarantee Value)

PERFORMANCE BOND FORMAT

Sui Southern Gas Company Limited,
ST-4/B, Sir Shah Muhammad Suleman Road,
Block 14, Gulshan-e-Iqbal,
Karachi.

Bank Guarantee #
Date of Issue :
Date of Expiry :
Amount :

Tender Enquiry No SSGC / SC /

Dear Sirs,

In consideration of your entering/having entered into Contract No. _____ with M/s. _____ hereinafter called "The Contractor" and in consideration of value received from the Contractor, we hereby agree and undertake as follows:-

1. To make un-conditional payment of Rupees _____ and un-conditional payment in such amount as you may require from time to time as and when called upon by you to do so, not exceeding in the aggregate payment of Rupees _____, being the amount covering liquidated damages and security for the due fulfillment by the Contractor of all liabilities, obligations, commitments and total and faithful performance of the above Contract by the Contractor as specified in the above mentioned Contract upon your written demand(s) without further recourse, question or reference to the Contractor or any other person in the event of the Contractor's default in compliance with its obligations, liabilities and faithful performance arising under and in pursuance of the Work committed by it in the above mentioned agreement of which you shall be the sole judge.
2. To accept written intimation(s) from you as sufficient evidence of the existence of default or non compliance as aforesaid on the part of the Contractor and to make payment immediately upon receipt of the written intimation.
3. To keep this guarantee in full force from the date of this guarantee till the Contractor's obligations as specified in the above referred Contract and all other obligations of the Contractor as are contained in the above contract are duly fulfilled by the Contractor to the satisfaction of the Company.
4. No grant of time or other indulgence to, or composition, or arrangement with the Contractor in respect of the performance of its obligations under and in pursuance of the said agreement or any clause thereof, with or without notice to us shall in any manner discharge or otherwise howsoever effect this guarantee and our liabilities and commitment there under.
5. The guarantee shall be binding on us and our successors in interest and shall be irrevocable.
6. This guarantee shall not be affected by any change in the constitution of the guarantor bank or the constitution of _____.
6. This guarantee shall remain valid upto _____.



DECLARATION FORM

(FORMAT OF DECLARATION)

M/s. _____ [the Seller/Supplier] hereby declares its intention not to obtain or induce the procurement of any contract, right, interest, privilege or other obligation or benefit from Sui Southern Gas Company Limited or any administrative subdivision or agency thereof or any other entity owned or controlled by Sui Southern Gas Company Limited (SSGCL) through any corrupt business practice.

Without limiting the generality of the foregoing, [the Seller/Supplier] represents and warrants that it has fully declared the brokerage, commission, fees, etc., paid or payable to anyone and not given or agreed to give and shall not give or agree to give to anyone within or outside Pakistan either directly or indirectly through any natural or juridical person, including its affiliate, agent, associate, broker, consultant, director, promoter, shareholder, sponsor or subsidiary, any commission, gratification, bribe, finder's fee or kickback, whether described as consultation fee or otherwise, with the object of obtaining or inducing the procurement of a contract, right, interest, privilege or other obligation or benefit in whatsoever form from SSGCL, except that which has been expressly declared pursuant hereto.

[The Seller/Supplier] certifies that it has made and will make full disclosure of all agreements and arrangements with all persons in respect of or related to the transaction with SSGCL and has not taken any action or will not take any action to circumvent the above declaration, representation or warranty.

[The Seller/Supplier] accepts full responsibility and strict liability for making any false declaration, not making full disclosure, misrepresenting facts or taking any action likely to defeat the purpose of this declaration, representation and warranty. It agrees that any contract, right, interest, privilege or other obligation or benefit obtained or procured as aforesaid shall, without prejudice to any other rights and remedies available to SSGCL under any law, contract or other instrument, be voidable at the option of SSGCL.

Notwithstanding any rights and remedies exercised by SSGCL in this regard, [the Seller/Supplier] agrees to indemnify SSGCL for any loss or damage incurred by it on account of its corrupt business practices and further pay compensation to SSGCL in an amount equivalent to ten times the sum of any commission, gratification, bribe, finder's fee or kickback given by [the Seller/Supplier] as aforesaid for the purpose of obtaining or inducing the procurement of any contract, right, interest, privilege or other obligation or benefit in whatsoever form of SSGCL.

SIGNATURE & STAMP

NOTE

1. The above declaration is to be furnished along with the bid on letter head, for bid(s) amounting to total bid value of Rs. 10,000,000/- (Ten million) or above.
2. Please note that submitting the declaration is a mandatory requirement.

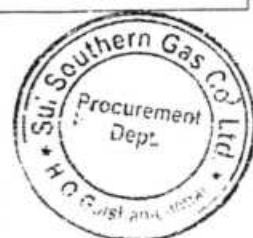

CONTRACT FORM

Contract No. **SSGC/SC/**

ARTICLES OF AGREEMENT

THIS AGREEMENT, made and entered into this _____ day of _____, 2018 by and between Sui Southern Gas Company Limited, having its office at ST-4/B, Sir Shah Muhammad Suleman Road, Block 14, Gulshan-e-Iqbal, Karachi, hereinafter referred to as the "Company" of the one part and M/s. _____ hereinafter referred to as the "Contractor", (which expression shall include the successors, of the said firm, heirs, executives, administrators and assigns of the Partners of the said firm individually or severally) of the other part.

WITNESSETH:

WHEREAS, under the procedures, bids have heretofore been received by the Company for carrying out "_____ work and the tender of the Contractor for the said work has been accepted by the Company.

NOW THEREFORE, for and in consideration of the promises, negotiations, covenants and agreements hereunder contained and to be performed by the parties hereto, the said parties hereby covenant and agree as follows:-

Article-1 Work and Cost of the Work:

- i) In consideration of the covenants and agreements to be kept and performed by the contractor and for the faithful performance of this Contract and the completion of the work embraced therein according to the specifications and conditions herein contained and referred to or agreed to in course of subsequent negotiations and in accordance with the Contract, the Company shall pay and the Contractor shall receive and accept as full compensation for everything furnish and done by the contractor under this agreement as sum of approximately **Rs.** _____ (_____), or such other sums as may be ascertained in accordance with the conditions of Contract, etc. and at rates quoted against each item of work and agreed to and accepted by the parties as one instrument, and at the times and in the manner prescribed by the conditions of the Contract.
- ii) The Contractor at his own proper cost and expense shall do all work and furnish all labour, materials, tools, supplies, machinery and other equipment and plant that may be necessary for the satisfactory completion of all the works as set forth in the contract documents.

Article-2 - Time:

The maintenance of a rate of progress in the works at a rate which will result in its completion within the specified time, is of the essence of the contract and the Contractor agrees to proceed with all the due diligence and care at all times to take all precautions to ensure the timely completion as defined herein; time being deemed to be essence of the Contract of part of the Contractor.

The said work shall be started on the Contractor's receipt from the Company of a written order to proceed, and the Contractor shall have the work called for duly and fully complete in total _____ months {including _____ () weeks mobilization period} from the date of issuance of such order.

Article-3 - Contract Documents:

It is understood and agreed that the contract documents which comprise this Contract are attached hereto and made a part hereof and consist of the following :-

- a) The Article of Agreement.



- b) Bid ((submitted vide letter No. _____, dated _____ comprising Letter of Invitation, Instructions to bidders, Scope of Work, Special and General Conditions of Contract, Tender Form, Bill of Quantities, Drawings, etc.).
- c) Company letter No. _____, dated _____.
Contractor letter No. _____, dated _____.
- d) Notice of Award (Letter of Intent (LOI) No.SSGC/MAT/S&C/_____, dated _____.
- e) Acceptance by the Contractor on the copy of LOI.
- f) Letter to Proceed No.SSGC/PROC/S&C/_____, dated _____.
- g) Performance Bank Guarantee No. _____, dated _____, amounting to Rs. _____ issued by M/s. _____.

It is agreed by the parties to the contract that this contract shall be executed in two counterparts; one copy to be retained in the office of the Sui Southern Gas Company Limited and one given to the Contractor.

IN WITNESS WHEREOF the parties hereto have executed this Contract at Karachi in two counterparts by their duly authorized representatives as of the day and year herein above set forth.

Signed for and on behalf of
M/s. Sui Southern Gas Company Limited

Signed for and on behalf of
M/s. _____ Karachi

Signature : _____

Signature : _____

Name : _____

Name : _____

In the presence of :

Signature : _____

Signature : _____

Name : _____

Name : _____

Signature : _____

Name : _____



Supplier code: _____

FORM-X

Bank account details form for all Beneficiaries

(Mandatory requirement for Digital Online Banking)

As per FBR Regulations ref # C.No.4 (24) IT-Budget/2021-142150-R dated 23rd Sept'2021 to make the payment online w.e.f. 01-11-2021. All beneficiaries are required to fill in the below details, which is mandatory:

Name of Firm: _____

Address of Firm: _____

CNIC #: _____

NTN #: _____

Bank Name: _____

Bank A/C Title name: _____

Branch code: _____

Bank A/c #: _____

(16 Digits)

Bank IBAN #: _____

(24 Digits)

Information already submitted.

Note: Please be attached copy of Cheque / Account Maintenance Certificate.(Mandatory)



Authorized Sign & Stamp

Date: _____

Note: All payments transactions will be made on above mentioned Account details. This is only a one time information to be provided by the all beneficiaries. Incase if the above detail has already submitted, please tick the box above "Information already submitted" and also ensure Form-X is duly signed & stamped.

ANNEXURE: I

Declaration of Ultimate Beneficial Owners Information for Public Procurement Contracts.

1. Name
2. Father's Name/Spouse's Name
3. CNIC / NICOP/Passport No.
4. Nationality
5. Residential address
6. Email address
7. Date on which shareholding, control or interest acquired in the business.
8. In case of indirect shareholding, control or interest being exercised through intermediary companies, entries or other legal persons or legal arrangements in the chain of ownership or control, following additional particulars to be provided:

1	2	3	4	5	6	7	8	9	10
Name	Legal form (Company/Limited Liability Partnership /Association of Persons/Single Member Company/Partnership Firm/Trusted/Any other Individual, Body Corporate (to be Specified)	Date of Incorporation / Registration	Name of Registering Authority	Business Address	Country	Email Address	Percentage of shareholding control or interest of BO in the Legal Person or Legal Arrangement	Percentage of shareholding, Control or Interest of Legal Person or Legal Arrangement in the Company	Identity of Natural Person who Ultimately owns or Controls the Legal Person or Arrangement

9. Information about the Board of Directors (details shall be provided regarding number of shares in the capital of the company as set opposite respective names).

1	2	3	4	5	6	7	8
Name and surname (in block Letter's)	CNIC no (in case of foreigner Passport No)	Father's / Husband's Name in Full	Current Nationally	Any other Nationality lies)	Occupation	Residentially address in full of the registered / principle office address for a subscribers other than natural Person	Numbers of shares taken by cash subscribers (in figures and words)
			Total numbers of shares taken (in figures and words)				

10. Any other information incidental to or relevant to beneficial owner(s).

Name and signature
(Person authorized to issue notice on behalf of the company)

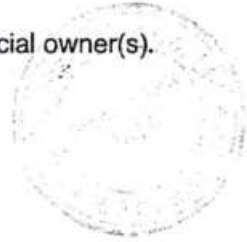

Form of Bid-Securing Declaration

[The Bidder shall fill in this Form in accordance with the instructions indicated.]

Date: [date (as day, month and year)]

No.: [number of Bidding process]

Alternative No.: [insert identification No if this is a Bid for an alternative]

To: [complete name of Procuring Agency]

We, the undersigned, declare that

We understand that, according to your conditions, Bids must be supported by a Bid-Securing Declaration.

We accept that we will be blacklisted and henceforth cross debarred for participating in respective category of public procurement proceedings for a period of (not more than) six months, if fail to abide with a bid securing declaration, however without indulging in corrupt and fraudulent practices, if we are in breach of our obligation(s) under the Bid conditions, because we:

- (a) have withdrawn our Bid during the period of Bid validity specified in the Letter of Bid; or
- (b) having been notified of the acceptance of our Bid by the Procuring Agency during the period of Bid validity; (i) fail or refuse to sign the Contract; or (ii) fail or refuse to furnish the Performance Security (or guarantee), if required, in accordance with the ITB.

We understand this Bid Securing Declaration shall expire if we are not the successful Bidder, upon the earlier of (i) our receipt of your notification to us of the name of the successful Bidder; or (ii) twenty-eight days after the expiration of our Bid.

Name of the Bidder: _____

Name of the person duly authorized to sign the Bid on behalf of the Bidder: _____

Title of the person signing the Bid: _____

Signature of the person named above: _____

Date signed: _____ day of _____

*: In the case of the Bid submitted by joint venture specify the name of the Joint Venture as Bidder

** Person signing the Bid shall have the power of attorney given by the Bidder attached to the Bid

[Note: In case of a Joint Venture, the Bid-Securing Declaration must be in the name of all members to the Joint Venture that submits the Bid.]



SUI SOUTHERN GAS COMPANY LIMITED

UNDERTAKING OF COMPLIANCE WITH INTEGRATED MANAGEMENT SYSTEM (IMS) MANUAL AND BLACKLISTING MECHANISM

I, _____ [Supplier's Authorized Representative Full Name], of _____ [Supplier Company Name], with principal office located _____ at _____ [Full Address], do hereby solemnly affirm and declare as follows:

1. That I am the duly authorized representative of _____ [Supplier Company Name], and have the legal authority to make this declaration on behalf of the company.
2. That I confirm having accessed, read, and fully understood the **Integrated Management System (IMS) Manual** provided by Sui Southern Gas Company Limited (SSGC), available at the official website:
<https://www.ssgc.com.pk/web/wp-content/uploads/2025/06/IMS-Mannual-1-1.pdf>
3. That _____ [Supplier Company Name] agrees to comply fully with all the policies, procedures, and responsibilities outlined in the IMS Manual, and will ensure that all relevant employees, contractors, and agents are made aware of and comply with the same.
4. That _____ [Supplier Company Name] acknowledges that failure to comply with the IMS Manual may result in corrective action, including but not limited to financial penalties as per SSGC policy and suspension or termination of business with Sui Southern Gas Company Limited (SSGC).
5. That the bidder has also read, understood, and accepted the **Blacklisting Mechanism of Sui Southern Gas Company Limited (SSGC)**, available at:
https://www.ssgc.com.pk/web/wp-content/uploads/2024/09/blacklisting_mechanism_2024.pdf
6. Any type of violation of the tender terms and non-performance will result in the enforcement of the Blacklisting Mechanism, which will be dealt with in accordance with the Blacklisting Rules/Mechanism.
7. This affidavit is made in good faith and for the purpose of affirming our commitment to health, safety, environmental standards, and compliance with the **Integrated Management System (IMS) Manual** and the **Blacklisting Mechanism** of Sui Southern Gas Company Limited (SSGC), as well as all other applicable policies and procedures of SSGC.

Signed at _____ [City] on this _____ day of _____, 20 .

Signature: _____
Name: _____
Designation: _____
Company Name: _____
Contact Details: _____

(Company Stamp / Seal Mandatory)

Witnessed by:

Signature of Witness: _____
Name of Witness: _____
Date: _____

Signature of Witness: _____
Name of Witness: _____
Date: _____



SSTW-05

Ref No _____

Dated _____

M/s _____

SNTN _____

Address _____

NOTICE UNDER RULE 3(1) OF THE SINDH SALES TAX SPECIAL PROCEDURE (WITHHOLDING) RULES, 2011.

Dear Sir,

Kindly note that we are a withholding agent under the Sindh Sales Tax Special Procedure (Withholding) Rules, 2011, and that we shall withhold and deduct the prescribed amounts of Sindh sales tax against your tax invoices in relation to the services provided or rendered by you to us. We hold NTN/FTN

2. We undertake to deposit the withheld/deducted amounts of Sindh sales tax in the Sindh Government's head of account "B-02384" against a SRB-prescribed PSID/Challan (SST-04 or SSTW-04) in the manner prescribed under the aforesaid Sindh Sales Tax Special Procedure (Withholding) Rules, 2011, and we shall provide you a certificate of deduction-cum-deposit in terms of rule 3(9) thereof.

Signature _____

Name _____

CNIC _____

Designation _____

Date _____

Official seal _____



AFFIDAVIT OF COMPLIANCE WITH INTEGRATED MANAGEMENT SYSTEM (IMS) MANUAL

I, _____ [Supplier's Authorized Representative Full Name], of _____ [Supplier Company Name], with principal office located at _____

[Full Address], do hereby solemnly affirm and declare as follows:

1. That I am the duly authorized representative of _____ [Supplier Company Name], and have the legal authority to make this declaration on behalf of the company.
2. That I confirm having accessed, read, and fully understood the Integrated Management System (IMS) Manual provided by Sui Southern Gas Company Limited (SSGC), available at official website [<https://www.ssgc.com.pk/web/wp-content/uploads/2025/06/IMS-Mannual-1-1.pdf>].
3. That _____ [Supplier Company Name] agrees to comply fully with all the policies, procedures, and responsibilities outlined in the IMS Manual, and will ensure that all relevant employees, contractors, and agents are made aware of and comply with the same.
4. That _____ [Supplier Company Name] acknowledges that failure to comply with the IMS Manual may result in corrective action, including but not limited to financial penalties as per SSGC policy and suspension or termination of business with Sui Southern Gas Company Limited (SSGC).
5. This affidavit is made in good faith and for the purpose of affirming our commitment to health, safety, and environmental standards in our operations and engagements with SSGC.

Signed at [City] this [day] of [month], [year].

Signature: _____
Name: [Full Name of Supplier Representative]
Designation: [Job Title]
Company Name: [Supplier Company Name]
Contact Details: [Phone, Email]

Witnessed by:

Signature of Witness: _____
Name of Witness: _____
Date: _____

Witnessed by:

Signature of Witness: _____
Name of Witness: _____
Date: _____



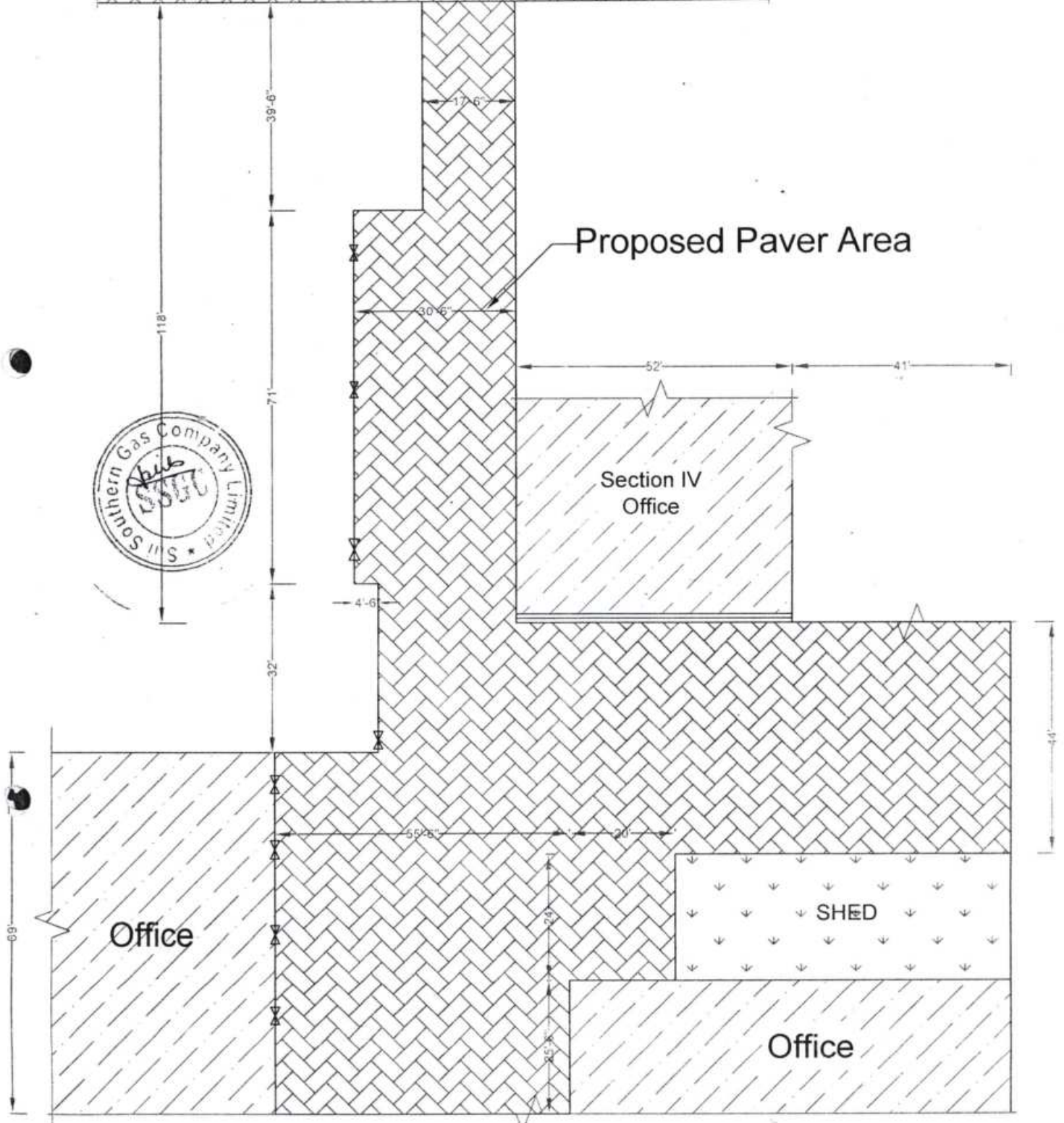
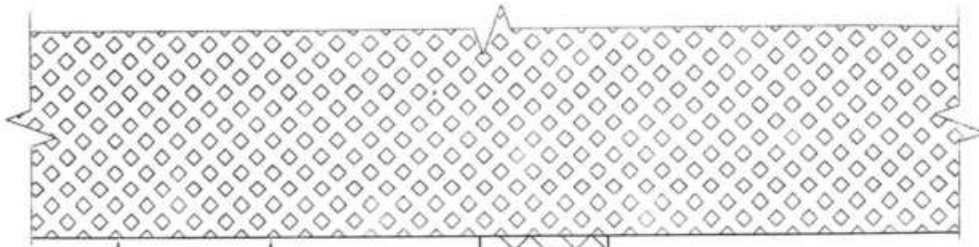

PAVER FLOOR AREA

	SUI SOUTHERN GAS COMPANY LIMITED: PROJECT & CONSTRUCTION (P&C) DEPARTMENT	Prepared By: Mustafa	Checked By Syed Zeeshan
	Sheet Title: PAVER FLOOR AREA	Date: 04 Nov, 2025	Verified By Muhammad Talib

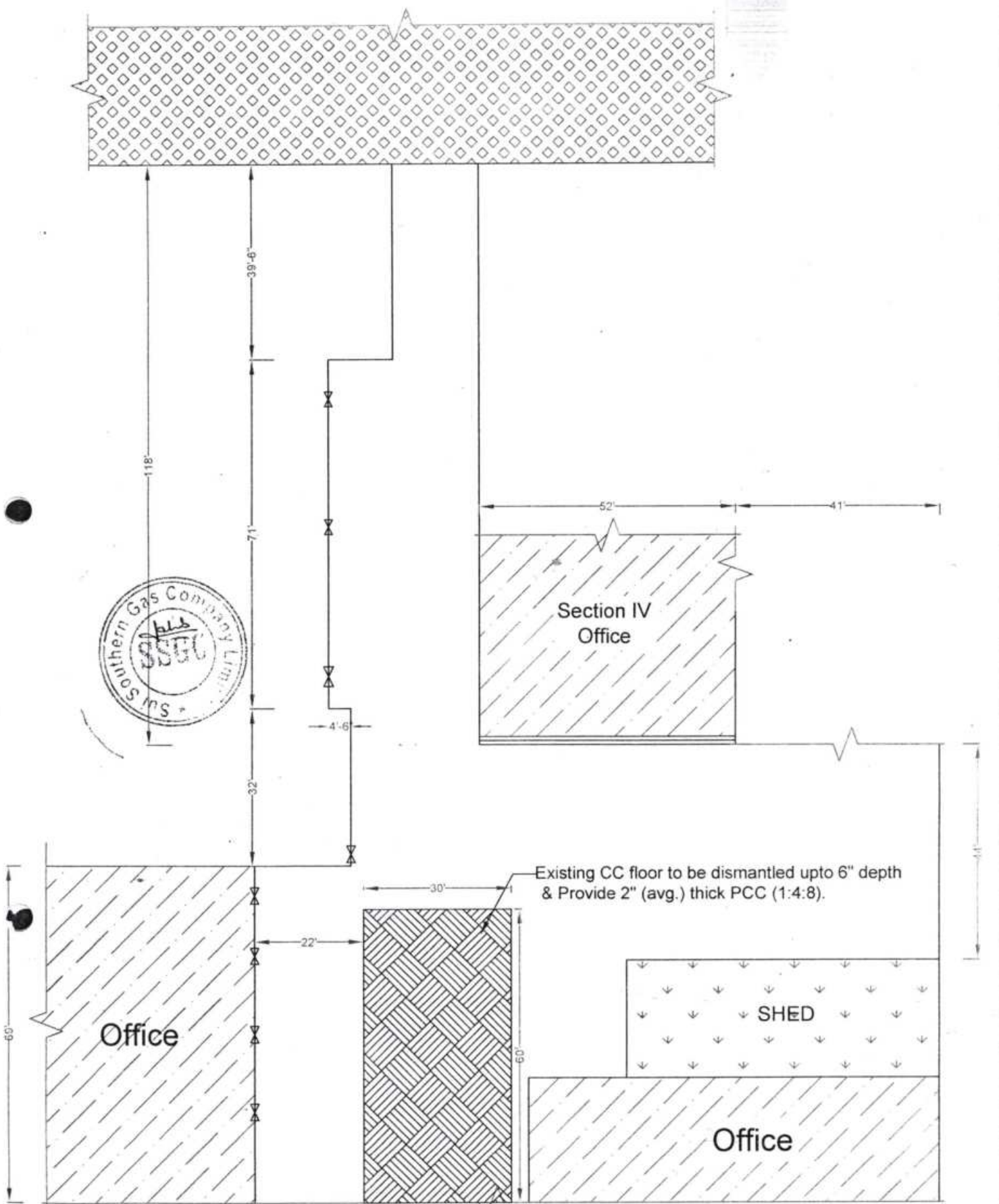

Dismantling & PCC Area

 SSGC	SUI SOUTHERN GAS COMPANY LIMITED: PROJECT & CONSTRUCTION (P&C) DEPARTMENT	Prepared By: Mustafa	Checked By Syed Zeeshan
	Sheet Title: Proposed Floor Cutting & 1:4:8 Lean Area	Date: 04 Nov, 2025	Verified By Muhammad Talib

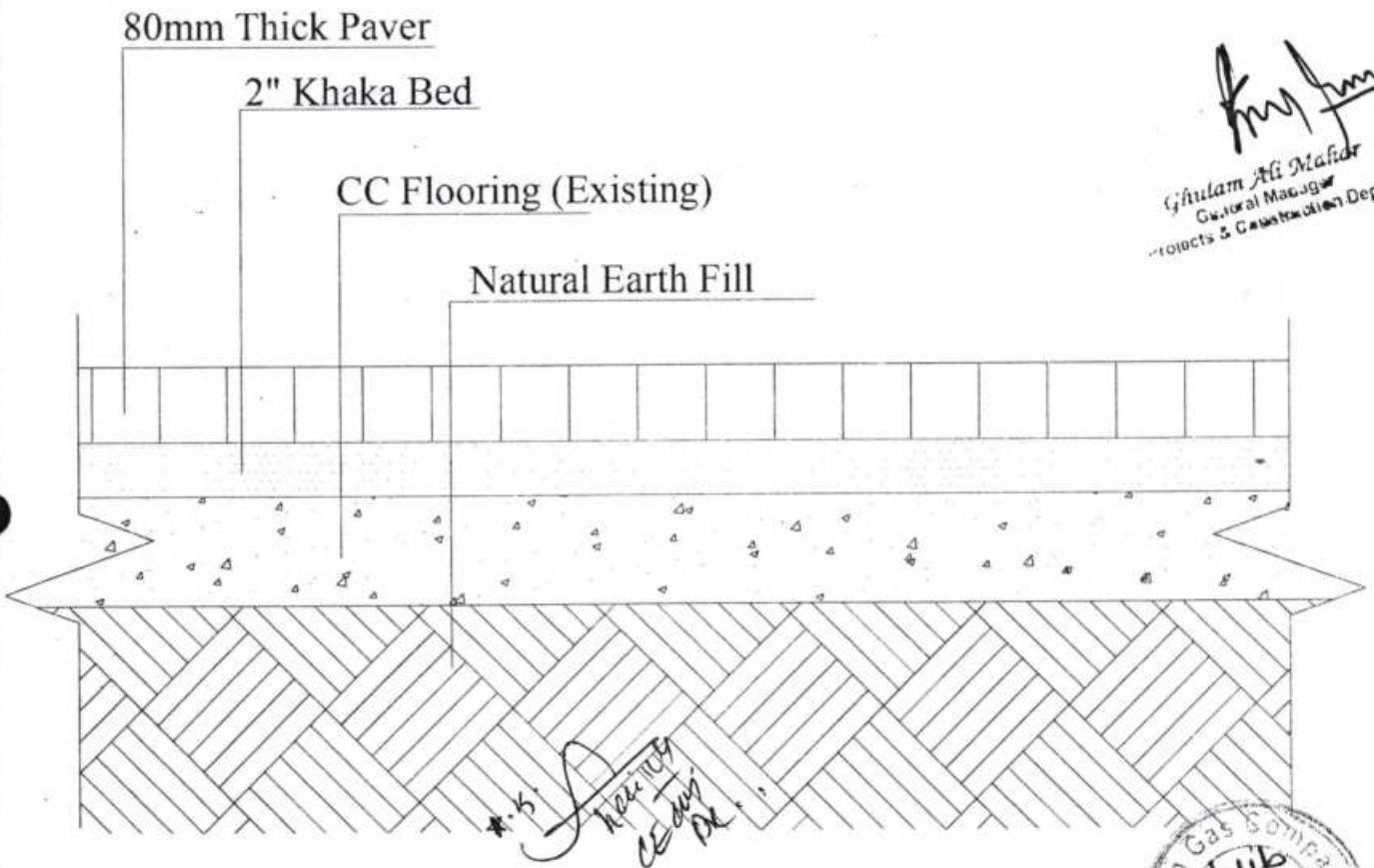
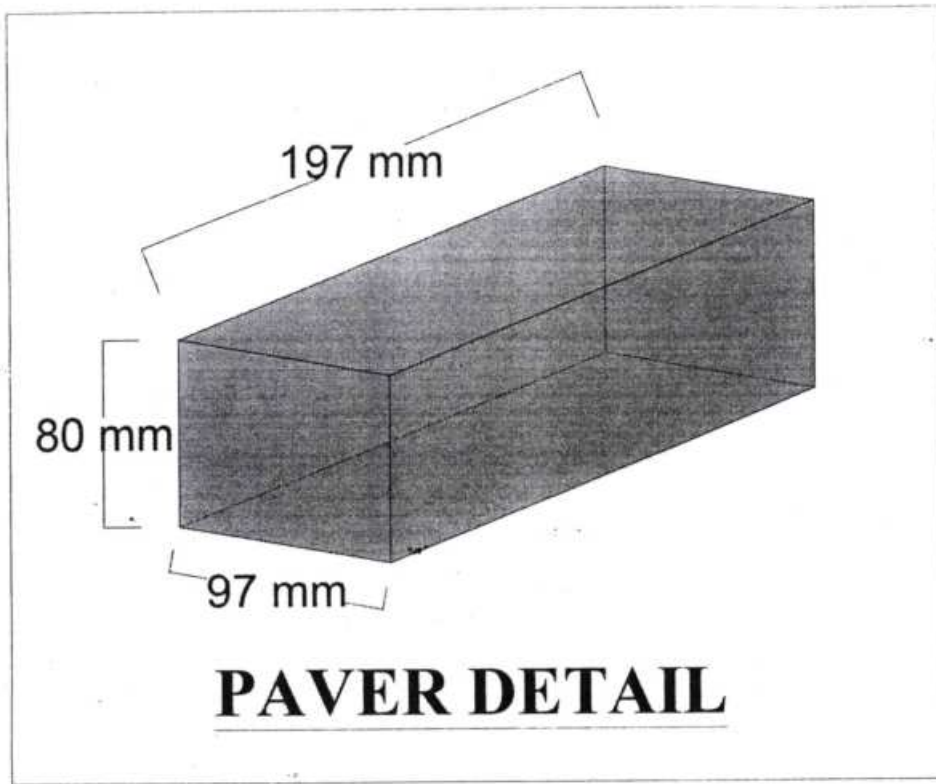

Handwritten signature: Ghulam Ali Mahid
 Ghulam Ali Mahid
 General Manager
 Projects & Construction Dept.

FLOORING DETAILS



	SUI SOUTHERN GAS COMPANY LIMITED: PROJECT & CONSTRUCTION (P&C) DEPARTMENT	Prepared By: Mustafa	Checked By: Syed Zeeshan
	Sheet Title: Flooring Details	Date: 04 Nov, 2025	Verified By: Muhammad Talib



سوی سدرن گیس کمپنی لمیٹڈ
پروکیورمنٹ ٹیپارٹمنٹ

تمام ٹھیکیداروں کے لئے معیاری ایٹوانزری

خدمات کی ادائیگی پر سندھ سیلز ٹیکس
(۱ جولائی ۲۰۲۴ سے نافذ العمل)

بس منظر

مطلع کیا جائے کہ:

1. فروری 2024 تک، SSGC نے سندھ میں فراہم کی جانے والی خدمات کے لیے وینڈرز کی انوائس ویلیو سے سندھ سیلز ٹیکس کی رقم کا 20% کاٹ لیا ہے اور اسے سندھ ریونیو بورڈ کے پاس جمع کرایا ہے، جبکہ وینڈرز بقیہ 80% خود جمع کراتے ہیں۔

2. مارچ 2024 سے جون 2024 تک، SSGC نے سندھ میں فراہم کی جانے والی خدمات کے لیے وینڈرز کی انوائس ویلیو سے سندھ سیلز ٹیکس کی رقم کا 80% کاٹ لیا ہے اور اسے سندھ ریونیو بورڈ کے پاس جمع کرایا ہے، جبکہ بقیہ 20% وینڈرز خود جمع کراتے ہیں۔

قانون میں ترمیم

سندھ ریونیو بورڈ (SRB) نے ود ہولڈنگ رولز میں ترمیم کی ہے جس کے تحت SSGC کو انوائس ویلیو سے سیلز ٹیکس کی رقم کا 20% کٹوتی کرنا ہوگی۔

سندھ سیلز ٹیکس ود ہولڈنگ کا نظر ثانی شدہ طریقہ کار

مندرجہ بالا ترمیم کے نفاذ کو یقینی بنانے کے لیے، 01 جولائی 2024 سے درج ذیل عمل کو نافذ کیا جا رہا ہے:

(1) 80% سیلز ٹیکس صرف 'ماضی' انوائسز پر کٹوتی جاری رہے گی (جہاں وینڈر نے پہلے ہی سرکاری خزانے میں 20% سیلز ٹیکس جمع کرایا ہے اس کا ثبوت فراہم کرتا ہے)۔

(2) 20% سیلز ٹیکس موجودہ اور مستقبل کے انوائسز پر کاٹا جائے گا (جبکہ 80% وینڈر براہ راست SRB کے ساتھ جمع کرائے گا)

یہ واضح رہے کہ صرف سندھ ود ہولڈنگ رولز وائٹ میں ترمیم کی گئی ہے دیگر رولز (انکم ٹیکس ود ہولڈنگ بلوچستان سیلز ٹیکس ود ہولڈنگ وغیرہ) میں کوئی تبدیلی نہیں کی گئی ہے۔



Sui Southern Gas Company Limited

Procurement Department

Standard Advisory to all Bidders

SUB: Sindh Sales Tax Withholding On Services Payment

(Effective from 1 July 2024)

Dear Sir,

Background

Please be informed that:

1. Uptil February 2024, SSGC deducted 20% of Sindh Sales Tax amount from Invoice value payable to a Vendor for services rendered in Sindh & deposit the same with Sindh Revenue Board, while remaining 80% is deposited by the Vendor themselves.
2. From March 2024 – June 2024, SSGC deducted 80% of Sindh Sales Tax amount from Invoice value payable to a Vendor for services rendered in Sindh & deposit the same with Sindh Revenue Board, while remaining 20% is deposited by the Vendor themselves

Amendment in Law

Sindh Revenue Board (SRB) has amended Withholding Rules thereby requiring SSGC to deduct 20% of sales tax amount from Invoice Value.

Revised Procedure for Sindh Sales Tax Withholding

In order to ensure implementation of above amendment, following process is being implemented 01. July 2024:

- 1) 80% Sales Tax to continue to be withheld on "Past" Invoices only (where Vendor has already deposited 20% Sales Tax in Government treasury provides evidence thereof).
- 2) 20% Sales Tax will be deducted on Current and future invoices (while 80% will be deposited by vendor directly with SRB)

It is needless to mention that only Sindh Withholding Rules have been amended white there is no change in other Rules (Income tax withholding Balochistan Sales Tax withholding; etc.)